

# COLORING YOUR WORLD IN STEEL



PRESENTING COMPLETE RANGE OF  
ROOFING SOLUTIONS UNDER ONE ROOF

- Hi-Rib Profile
- Tile Profile
- GC & GP Sheets
- Door Frames
- Purlins
- Liner Profile
- Pencil Profile
- Coloured SDR Screws
- Accessories
- Our Other Products

# MegaShine Colour Coated Profile Sheets

GO FOR A REVOLUTIONARY TECHNOLOGY THAT GIVES COLOUR COATED SHEETS A DURABLE LIFE AND ELEGANT FINISH.

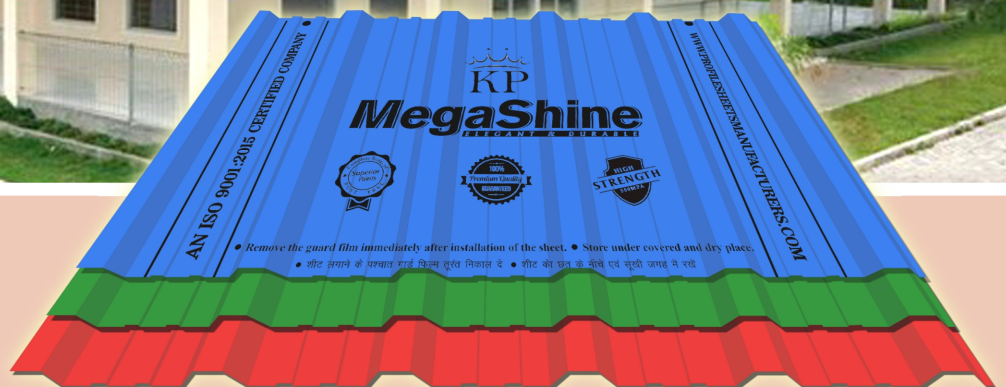

MegaShine Colour Coated Profile Sheets are made with most advance technology which offers highly cost efficient & sturdy solutions for your residential & industrial needs. World-class manufacturing process, Superior steel base and multiple layers of anti-corrosive coatings provides **MegaShine** Sheets more **DURABLE** life and **ELEGANT** finish.

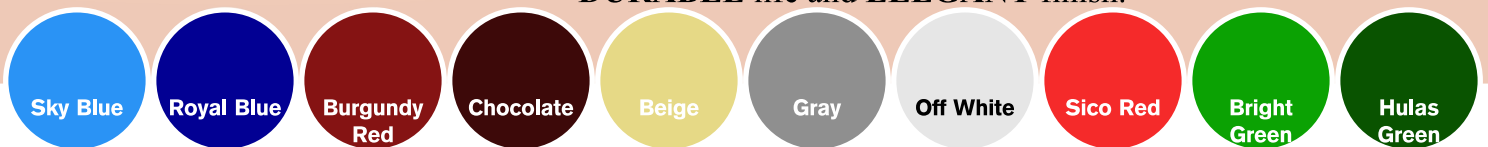

International  
Organization for  
Standardization

## MegaShine Colour Coated Profile Sheets

### Product Specification:

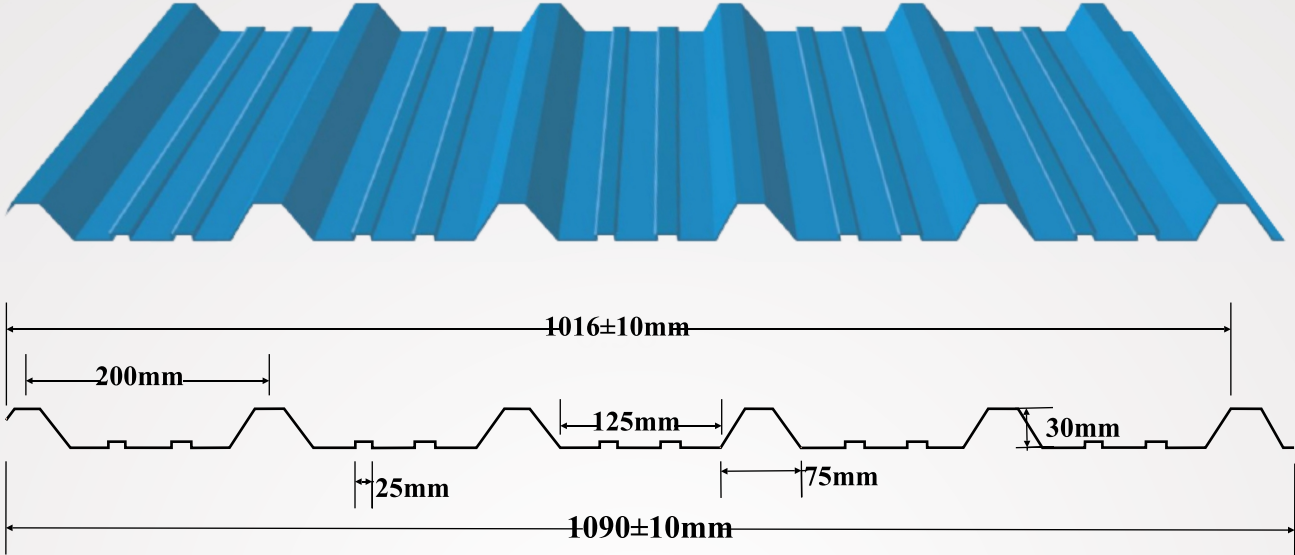

MegaShine & MegaShine <sup>+</sup>	
Paint Coat	Up to 40 microns
Zinc Coat	Up to 120 GSM
Base Metal	Galvanized Paint with Dual Coating
Nominal Thickness (TCT)	0.3-0.8 mm.
Length	As Per Customer Requirement
Wind Velocity	Up to 180 Km/Hr
Yield Strength	Up to 650 MPa
MegaShine <sup>+</sup> AZ	Up to AZ150
Guard Film	40 Microns



Durable



SAVINGS IN  
NUMBER OF  
SHEETS &  
LABOUR COST



ADVANCED  
DESIGN FOR  
BETTER  
STRENGTH



PERFECT  
OVERLAPPING  
FOR IDEAL  
WATERPROOFING



HIGH TENSILE  
STRENGTH UPTO  
650MPa



WITHSTANDS  
WIND  
VELOCITY UPTO  
180Km/Hr



4 LAYERS OF  
COATING



# KP Galvanized Corrugated Sheets (G.C.) MegaShine Colour Coated Corrugated Sheets



KP Galvanized and Colour Coated Corrugated Sheets are most admired and sworn for its quality, ruggedness and durability. Best in line machinery is used to corrugate steel which ensures a perfect finish that is uniform in design, colour, gloss and thickness. Strength of superior steel base and anti-corrosive qualities of zinc coating and colour coating offers quality product that protects against climatic harshness and ensures dependability for a long life.

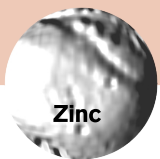
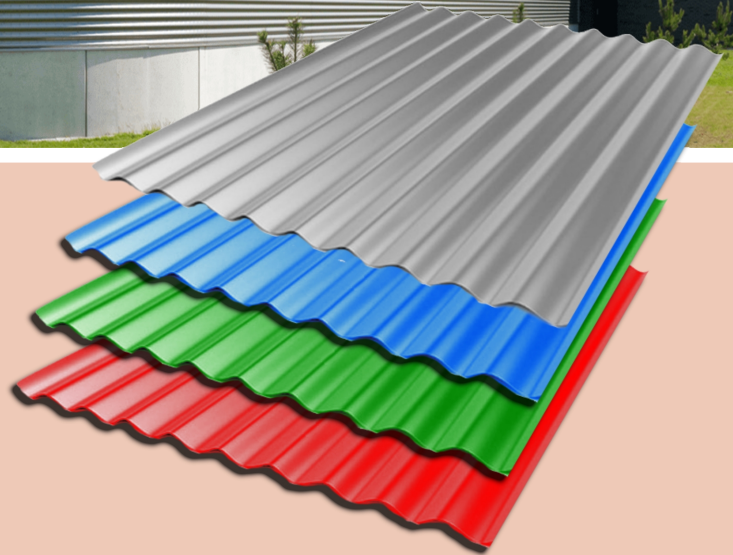

Zinc



Royal Blue



Burgundy Red



Chocolate



Cherry



Sky Blue



Sico Red



Bright Green



Hulas Green



**KP Galvanized Corrugated Sheets (G.C.)  
MegaShine Colour Coated Corrugated Sheets**

**Product Specification:**

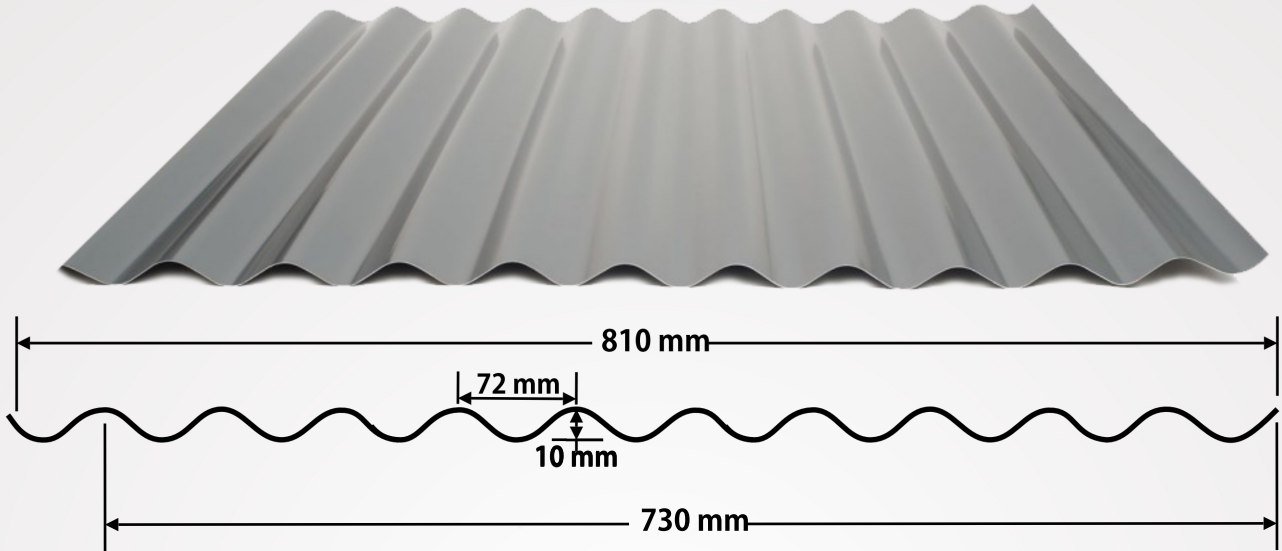

**KP Corrugated Sheets & MegaShine Colour Corrugated Sheet**

<b>Sheet Width</b>	810 mm
<b>Zinc Coat</b>	Up to 150 GSM
<b>Base Metal</b>	Galvanized Plain
<b>Nominal Thickness (TCT)</b>	0.2-0.8 mm.
<b>Length</b>	As Per Customer Requirement
<b>Wind Velocity</b>	Up to 180 Kmph
<b>Yield Strength</b>	Up to 650 MPa
<b>Guard Film</b>	Optional (MegaShine Coloured Sheets)
<b>Paint Coat</b>	40 microns (MegaShine Coloured Sheets)



**Durability**



**High Solar Reflectivity**



**Assured Performance**



**Environment Friendly**



**A surety of Genuineness**

## KP Door Frames

Security of Steel & Stunning Finish!!!



The KP Door Frames are manufactured from high grade steel using state-of-the-art technology. Every product is uniform in quality and finish; offering complete peace of mind to its users in terms of price, quality, durability and security. Strength of GI/GL steel base and corrosion resistance properties of multiple layers of paint provide a long life and aesthetic finish. Fully automatic manufacturing process leaves no room for human error.

0.80  
20G

0.90  
19G

1.00  
18G

1.10  
17G

1.20  
16G

1.40  
15G



International  
Organization for  
Standardization



**KP Door Frames**

**Product Specification:**

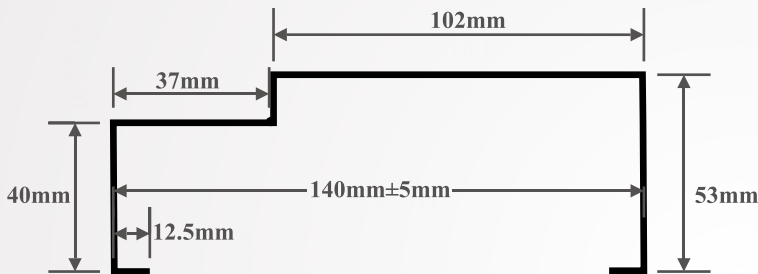
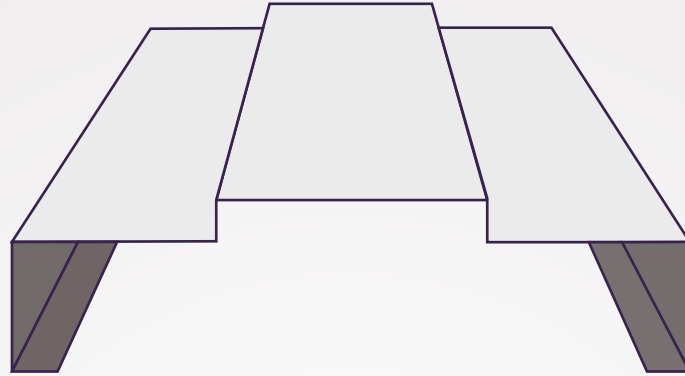

Single Collar Door Frame

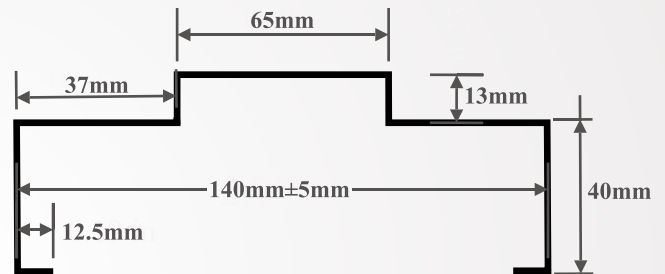

Double Collar Door Frame



**MegaShine Door Frames**

<b>Paint Coat</b>	Up to 40 microns
<b>Zinc Coat</b>	Up to 120 GSM
<b>Base Metal</b>	Galvanized Paint with Dual Coating
<b>Nominal Thickness (TCT)</b>	0.8-1.5 mm.
<b>Length</b>	As Per Customer Requirement
<b>Yield Strength</b>	Up to 1000 MPa
<b>Megashine<sup>+</sup> AZ</b>	Up to AZ150
<b>Guard Film</b>	40 Microns (OPTIONAL)
<b>Frame Types</b>	Single Collar & Double Collar



**DURABLE**



**COST SAVER**

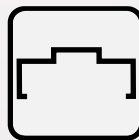

**ADVANCED DESIGN FOR BETTER STRENGTH**



**HIGH TENSILE STRENGTH UPTO 650MPa**



**4 LAYERS COATING**



# MegaShine

ELEGANT & DURABLE  
Colour Coated Profile Sheets

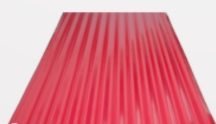
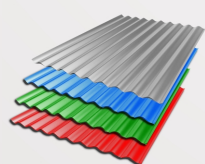

Factory : Vill. Hedon, Ludhiana-Chandigarh Road, Samrala,  
Distt. Ludhiana, PB 141114

Office : KP ENTERPRISES, Overlock Road, Ludhiana, PB 141003  
Contact No. 75083-17000, 75084-17000, 75085-17000

Email: sales@kangprofiles.com | Website: www.kangprofiles.com



Scan Me